

## Serial to Ethernet converter (Super Port) (USR-K3)

File version: V1.0.10

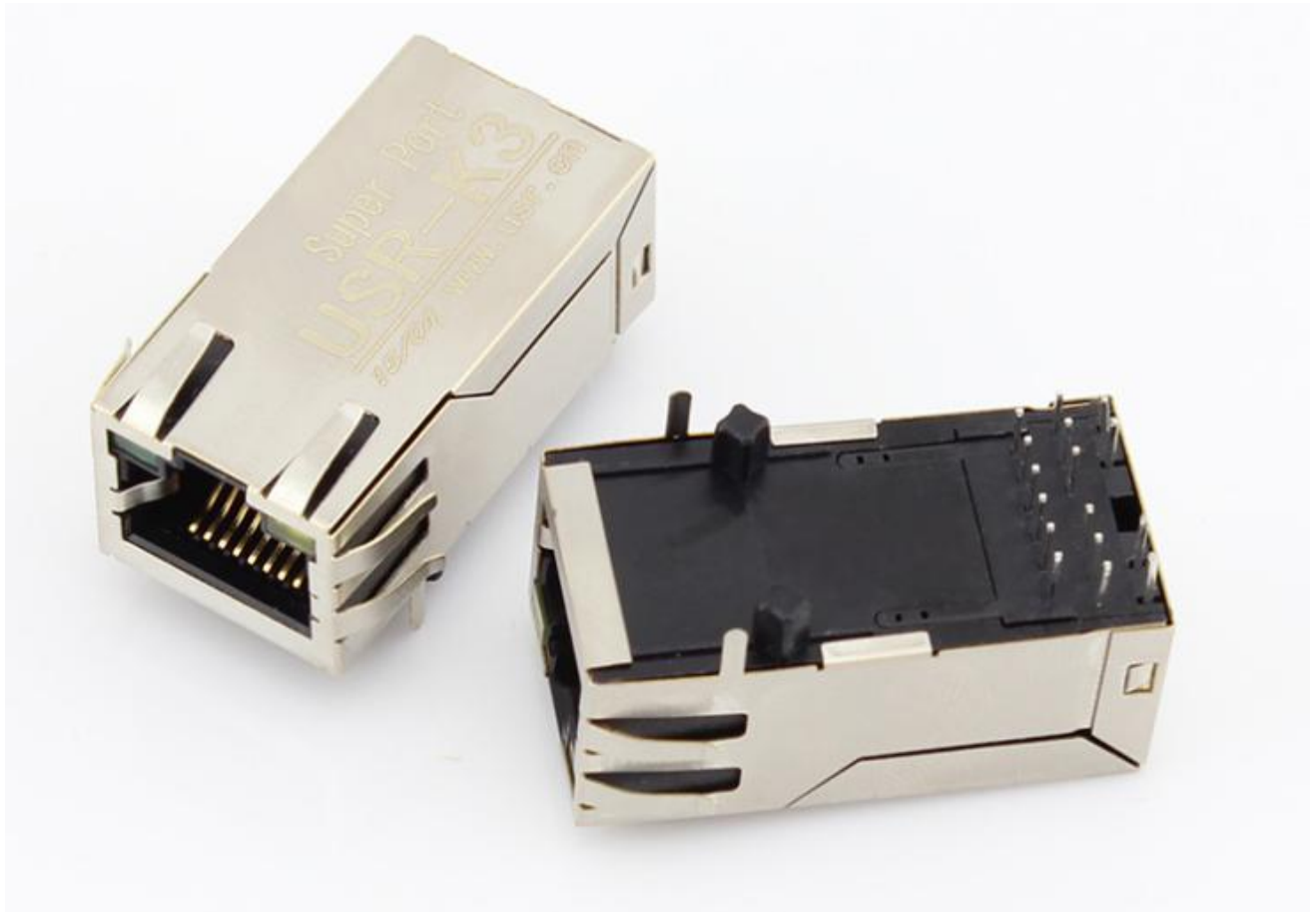

Jinan USR IOT Technology Co., Ltd. works on LAN and WAN and wireless for MCU to Ethernet Solutions, Ethernet, WIFI, GPRS, and Wireless modules, we can supply custom design for those usage, looking forward to cooperate with you.

## Contents

Serial to Ethernet converter(Super Port).....	1
1. Introduction.....	4
1.1. Overview.....	4
1.2. Features.....	4
1.2. Applications.....	5
1.3. Order information.....	5
1.4. Electrical characteristics.....	5
2. Module Test.....	7
2.1. Hardware connection.....	7
2.2. Login.....	8
2.3. Default parameter test.....	9
3. Work mode.....	11
3.1. UDP mode.....	11
3.2. TCP Client mode.....	12
3.3. UDP Server mode.....	13
3.4. TCP Server mode.....	14
3.5. Httpd Client mode.....	15
4. Hardware.....	17
4.1. Hardware.....	17
4.2. Pin definition.....	17
4.3. Connection diagram.....	20
4.4. LED.....	20
4.5. RJ45 interface.....	20
5. Parameters configuration.....	21
5.1. Web page.....	21
5.2. network command(setup software).....	21
6. Specific functions.....	22
6.1. ModbusRTU to ModbusTCP.....	22
6.2. Hardware flow control(RTS/CTS).....	23
6.3. MAC address.....	24
6.4. Packet time and Packet length.....	24
6.5. Sync baud via net(2217).....	25
6.6. Webserver port.....	25
6.7. Module id and id type.....	25
6.8. Device name.....	26
6.9. Buffer data before connected.....	27
6.10. Reset timeout.....	28
6.11. Local IP config.....	28
6.11.1. Static IP.....	29

---

6.11.2. DHCP .....	29
6.12. DNS.....	29
6.13. Comm param.....	30
1.1. Username and password.....	错误！未定义书签。
6.14. Firmware revision.....	30
6.15. RS485.....	30
6.16. Firmupdate.....	30
6.17. Common questions.....	33
6.17.1. Work across network segment.....	33
6.17.2. Ping is OK but can not open web pages.....	33
6.17.3. After firm update, can not open web page.....	33
6.17.4. When connection established, server received serval chars.....	33
6.17.5. Every serval seconds, module reconnect.....	33
7. Contact us.....	34
8. Modified history.....	35

# 1. Introduction

## 1.1. Overview

The USR-K3 product is a small package, intelligent plug-and-play UART to Ethernet adapter. K3 enables any device or machine with a serial port(UART), to become Ethernet network and Internet enabled, and have network data transmit ability. It features a powerful built-in device server, so you can access your serial device from anywhere in the world over internet! The USR-K3 is easily configured via local network, or through the serial port and web pages.

We Provide Network products and the best service to our customers.

• Chips • Modules • Software • Products

## 1.2 Features

1. New Cortex-M4 kernel, industrial working temperature range(-40~85°C), elaborate optimization TCPIP protocol stack, stable and reliable.
2. Auto-MIDX function, discretionarily connect cross-over or direct network cable, automatic switching.
3. Support TCP Server, TCP Client, UDP, UDP Server, HTTPD Client,websocket, various of ethernet protocols.
4. Support virtual serial port, provide corresponding software.
5. Serial port highest baud rate from 600bps to 1024Kbps.
6. Single DC3.3V supply.
7. Support DHCP. User can find the device within LAN network through the UDP broadcast protocol(using software USR-TCP232-M4 Setup).
8. Provide PC TCP/IP SOCKET programming example, VB, C++, Delphi, Android, IOS.
9. A built-in web page, also parameter setting via web, can customize web pages for users.
10. Can also set parameters via UDP broadcast, provide the set up protocol.
11. RJ45 status indicator light, RJ45 interface built-in isolation transformer, 2 KV isolation.
12. The global unique MAC address bought from IEEE, the user can also use their own mac(please state when you make order).
13. Support upgrade firmware via network.
14. Support visit IP and domain name at the same time
15. Support up to 8 link from client when act as TCP Server, same data will be send to all client.
16. Can modify http server port from default port 80 for module built-in http server.
17. Support Keepalive, detect a dead link quickly and make connection more stable.

## 1.2. Applications

- Fire and Security Panels
- Vending Machines
- Point of Sale Terminals
- Remote equipment management
- IT management services
- Access Control
- Industrial Control
- Home Automation
- Instrumentation
- Building Control
- Power Management

## 1.3. Order information

Type	Part Numbers	Electric interface
Super Port	USR-K3	1*UART, built-in RJ45

Diagram 1-1 Order information

- Config method: comm port/network/webpage
- Power supply: DC3.3V only
- Inches: 33.02 x 19.01 x 19.15 (mm, include the Shrapnel)
- Work temperature: -40~+85°C
- Store temperature: -40~85°C, 5~95%RH
- Buffer of comm port: 2K byte
- Buffer of Network: 16K byte

## 1.4. Electrical characteristics

All the data is get at tempture 25C, network cable plug in, max data transmission(10ms, 20 byte, sending data constantly).

	Input Voltage range	Current cosumption at 3.3V
--	---------------------	----------------------------

---

USR-K3	DC3.3V	120mA(115-125)
--------	--------	----------------

## 2. Module Test

If you have any question, please contact us the in the client support center:

<http://h.usriot.com/index.php?c=frontTicket&m=sign>

### 2.1. Hardware connection

The picture below is a serial device server of USR-K3. It have 1 UART to ethernet interafce.

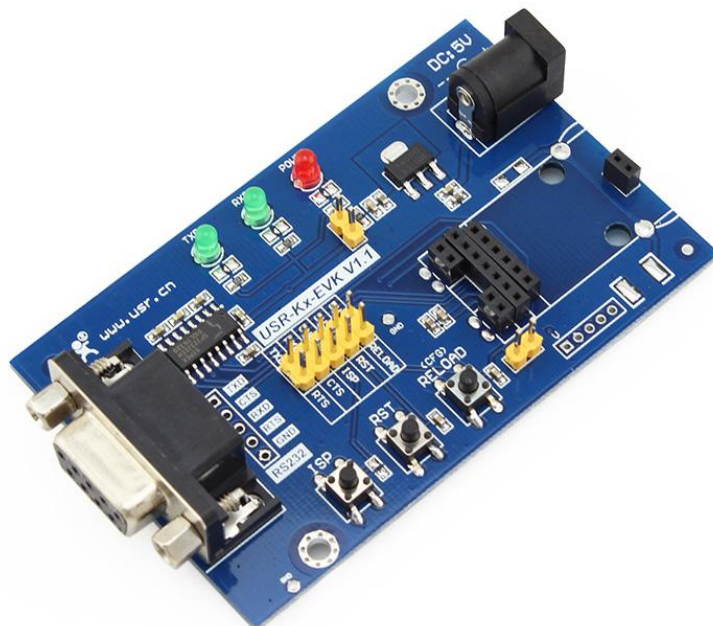

Diagram 2-1 Development Kit

Power the eval board with DC5V adaptor(make sure you can supply at least 200mA current at DC5V, USR-K3 only accept DC3.3V, but since we are using a eval board, DC5V will do)

Connect K3's RJ45 to PC directly with network cable(No need to distinguish cross or direct connect cable), or connect the module and PC via switch or router and set the PC's ip address to 192.168.0.201(must be a format of 192.168.0.xxx), netmask 255.255.255.0.

Connect eval board's RS232 and PC's comm port together, with a standard male-female extend cable(default no-cross-over cable).

Here is USR-K3's default net configuration,

IP address: 192.168.0.7

Subnet mask: 255.255.255.0

The default gateway: 192.168.0.1

## 2.2. Login

Open a browser, type and Login above IP address `http://192.168.0.7`, you will enter module's setup web pages. There will be a windows login verify dialog.

User name and password are both "admin", this can be modified after login into the system.

Default user name: admin

Default password: admin

After you login, you can see webpage as follow,

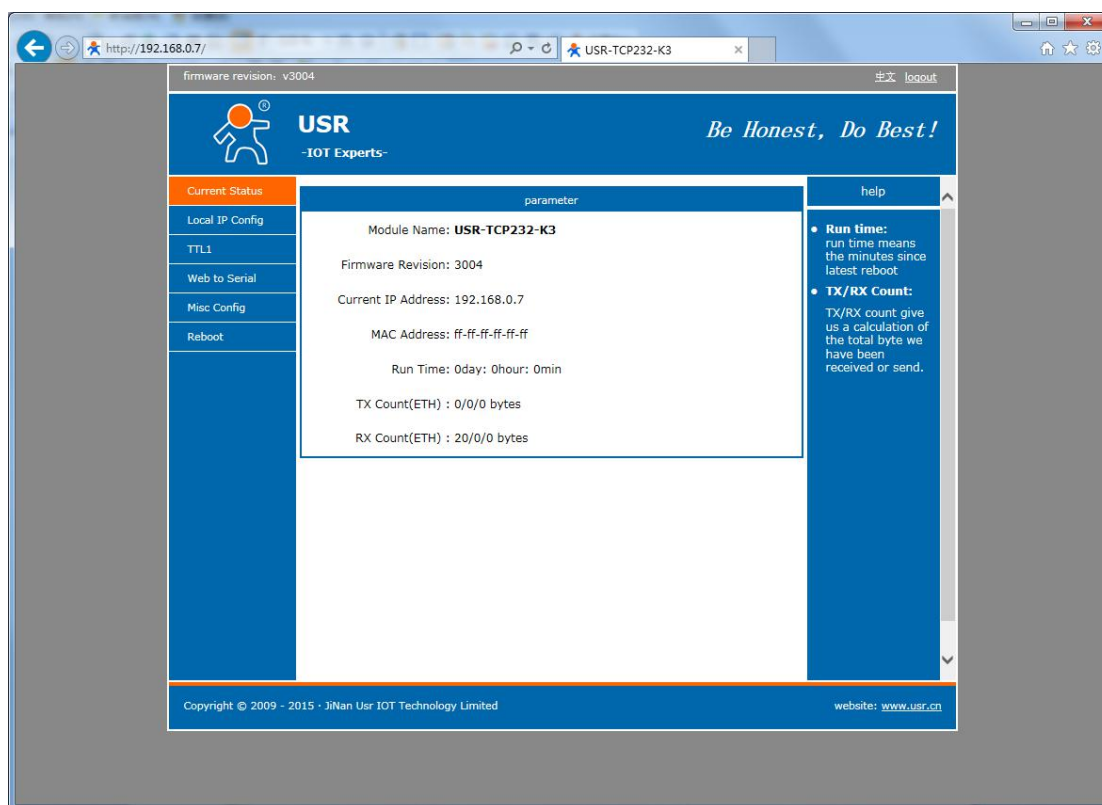

Diagram 2-2 webpage after login

- Current Status: the module's name, current ip, firmware revision, and other status information
- Local IP Config: the module's ip address, submask and gateway parameter
- TTL1: the module's serial to ethernet parameter
- Web to Serial: web to serial data transparent
- Misc Config: some parameter such as user name and password parameter
- Reboot: user can reboot/restart module from here



USR
Be Honest, Do Best!

-IOT Experts-

parameter	help
Baud Rate: <input style="width: 80px;" type="text" value="115200"/> bps	<ul style="list-style-type: none"> <li>● <b>baud:</b> 300~1024000bps (232 and 485 can only up to 115200bps)</li> <li>● <b>flowcontrol and RS485</b> default RS485</li> <li>● <b>local port</b> 1~65535. when TCP Client, set this to 0 means use random local port</li> <li>● <b>remote port</b> 1~65535</li> <li>● <b>packet time</b> 1~255ms, default 10ms; when baud &lt;=4800bps, pls set packet time to 50 ms</li> </ul>
Data Size: <input style="width: 40px;" type="text" value="8"/> bit	
Parity: <input style="width: 60px;" type="text" value="None"/>	
Stop Bits: <input style="width: 40px;" type="text" value="1"/> bit	
Flow Control and RS485: <input style="width: 80px;" type="text" value="RS485"/>	
Local Port Number: <input style="width: 60px;" type="text" value="23"/>	
Remote Port Number: <input style="width: 60px;" type="text" value="23"/>	
Work Mode: <input style="width: 80px;" type="text" value="TCP Server"/> <input style="width: 60px;" type="text" value="None"/>	
TCP Server detail: <input style="width: 60px;" type="text" value="default"/> type	
Remote Server Addr: <input style="width: 150px;" type="text" value="192.168.0.201"/> [ N/A ]	
Timeout: <input style="width: 60px;" type="text" value="0"/> seconds (< 256, 0 for no timeout)	
UART packet Time: <input style="width: 60px;" type="text" value="10"/> ms (< 256)	
UART packet length: <input style="width: 60px;" type="text" value="512"/> chars (<= 1460, 0 for no use)	
Sync Baudrate(RF2217 similar): <input checked="" type="checkbox"/>	
<input type="button" value="Save"/> <input type="button" value="Cancel"/>	

## 2.3. Default parameter test

To test briefly in default working mode, on the foundation of the hardware connection, use the matched software USR-TCP232-Test to make transmitting and receiving test. The left side is serial port, use software default settings, the right side is the network part, set to TCP Client and server to be IP 192.168.0.7, port 23.

By default, the two COM port to be set as TCP Server mode, port is 23.

This illustration shows the 10 ms two-way simultaneous automatically transmit screenshots. As the allocated memory of the display control is limited, in order to test large amount of data transceiver, here will suspend the receive display, only statistical data. Below is the effect after testing for a few hours, and transmitting millions of bytes. Stable and reliable, without a byte loss.

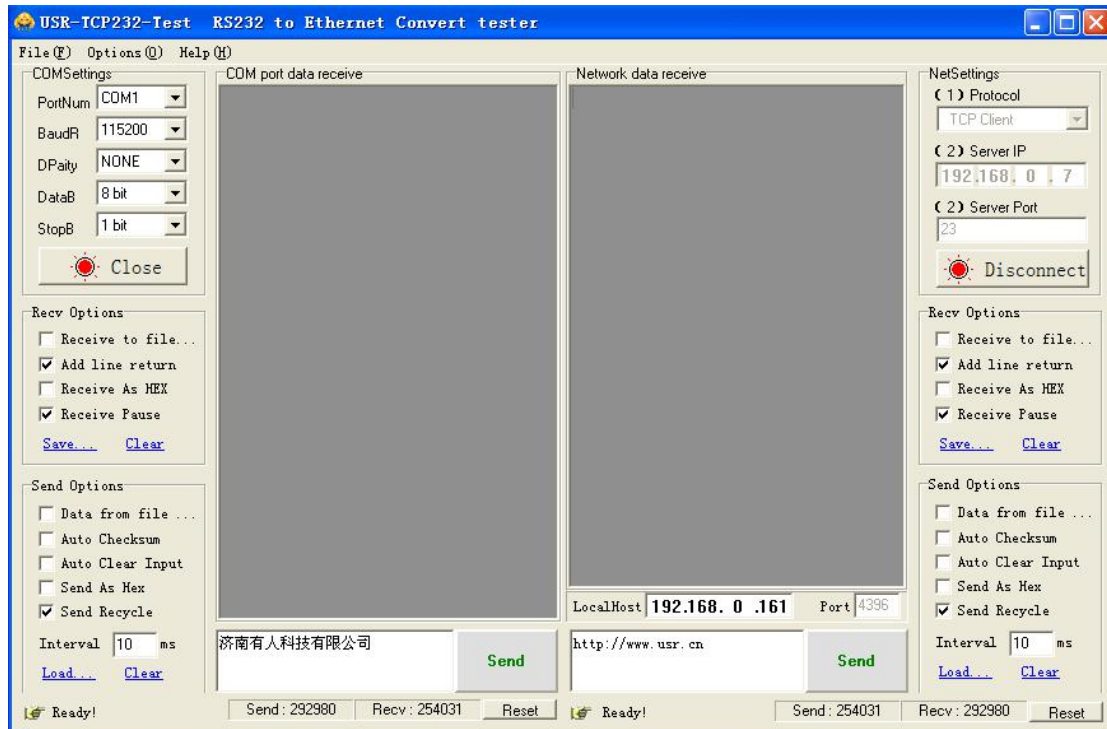

Diagram 2-3 default working mode communication

### 3. Work mode

#### 3.1. UDP mode

When in UDP mode, after power on, module listen on specific port.



Diagram 3-1 UDP mode

When received data from this udp port, send it to serial port; otherwise, when data is received from serial port, send it to ethernet.

The assist software can be download from link below:

<http://www.usriot.com/Download/199.html>

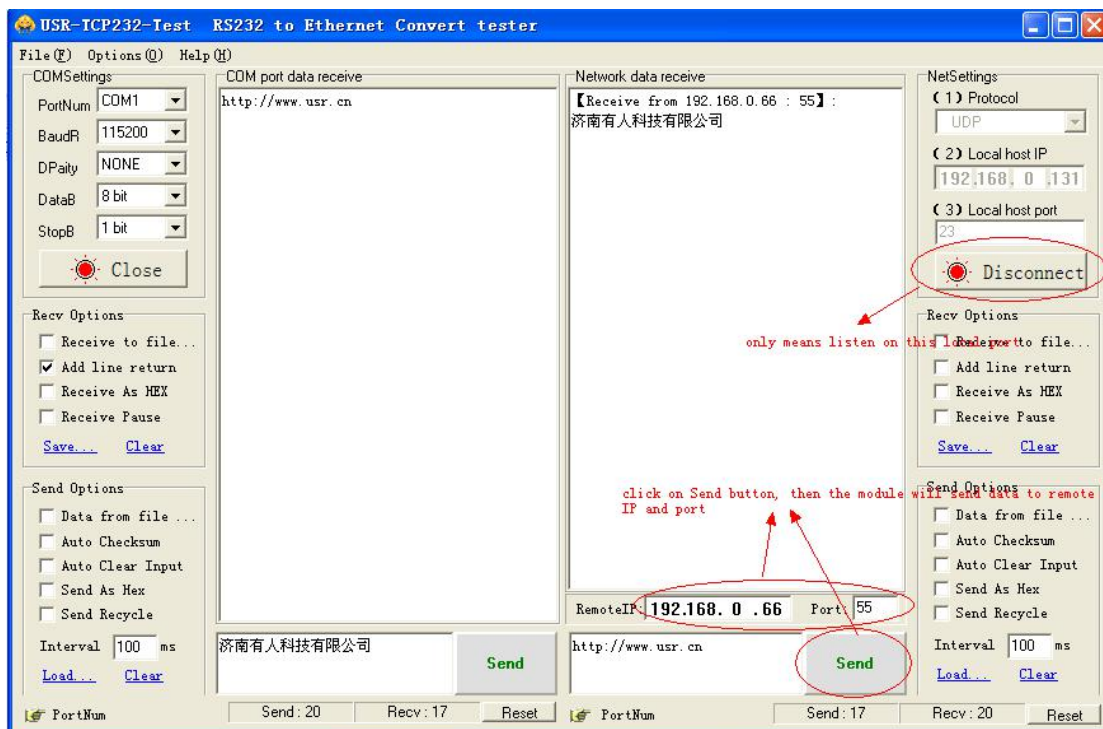

Diagram 3-2 UDP mode communication test

Note:

- 1) local port and remote port can be different.
- 2) Max UDP send length(ethernet to serial) is 1472 bytes. If you want to send more than 1472 Bytes, please div it into shorter packet.

### 3.2. TCP Client mode

Open web pages and config module to

Telnet Mode: TCP Client

Remote port number: 23

Telnet Server Addr: 192.168.0.131

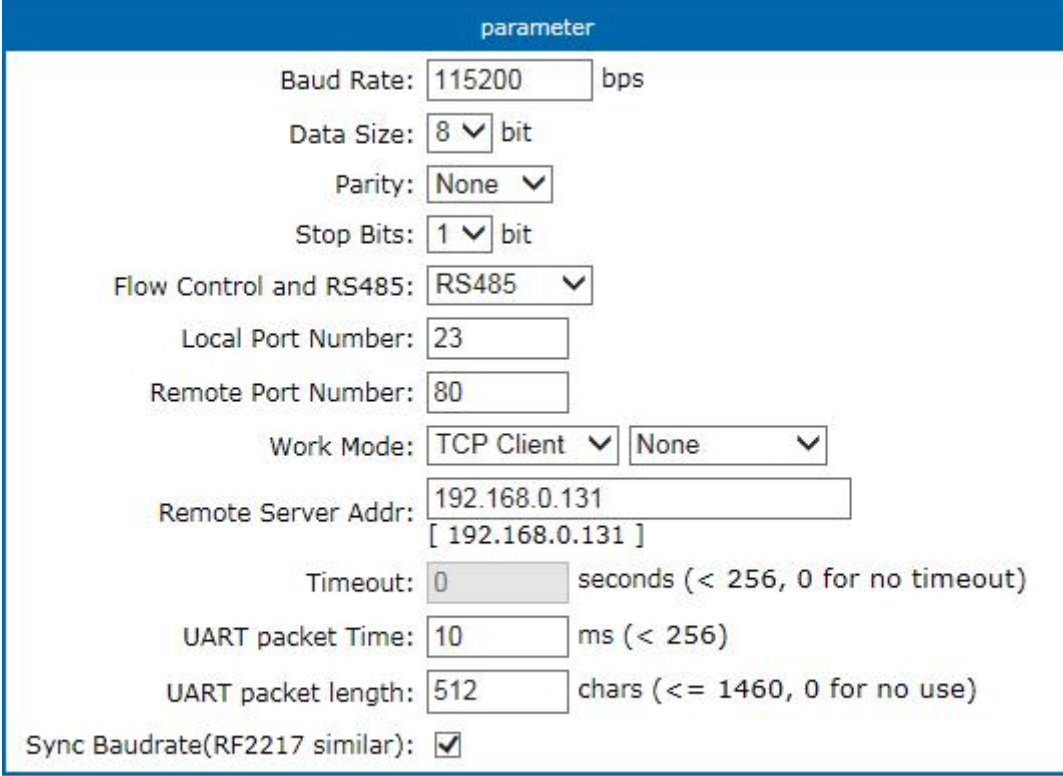

The screenshot shows a configuration window titled "parameter" with the following fields and values:

- Baud Rate: 115200 bps
- Data Size: 8 bit
- Parity: None
- Stop Bits: 1 bit
- Flow Control and RS485: RS485
- Local Port Number: 23
- Remote Port Number: 80
- Work Mode: TCP Client (selected), None
- Remote Server Addr: 192.168.0.131 [ 192.168.0.131 ]
- Timeout: 0 seconds (< 256, 0 for no timeout)
- UART packet Time: 10 ms (< 256)
- UART packet length: 512 chars (<= 1460, 0 for no use)
- Sync Baudrate(RF2217 similar):

At the bottom of the window are "Save" and "Cancel" buttons.

Diagram 3-3 TCP Client mode

Use USR-TCP232-Test,

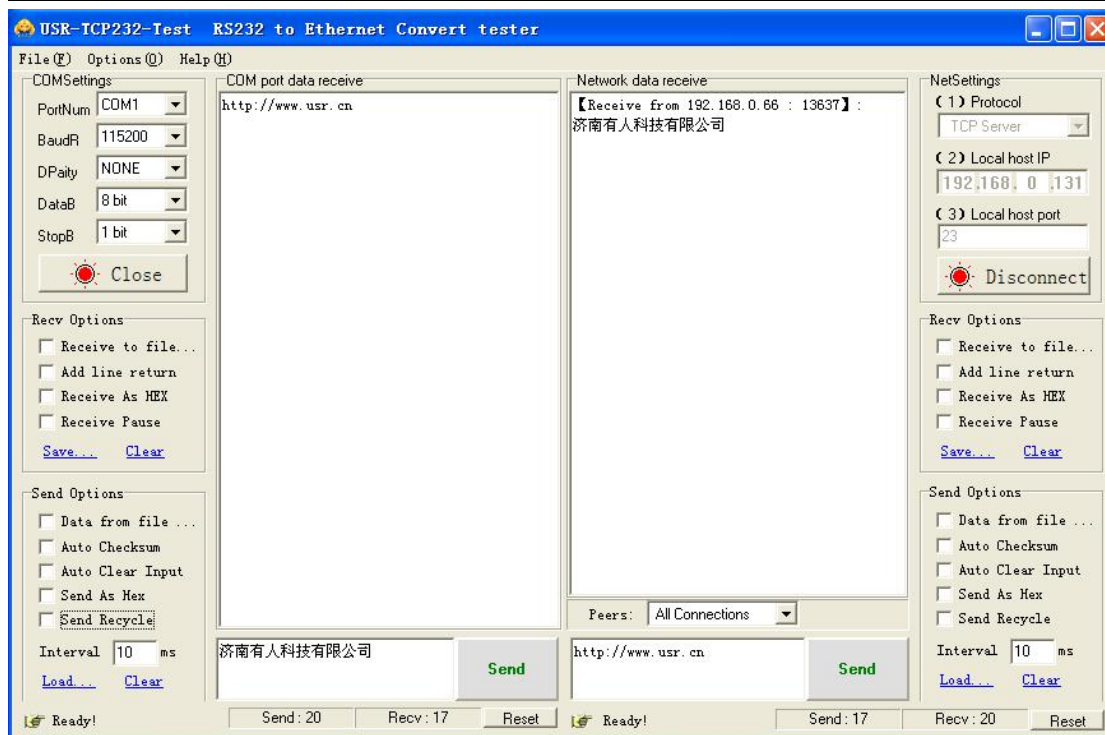

Diagram 3-4 TCP Client communication test

### 3.3. UDP Server mode

Like the socket UDP server in pc API. Many to one data transfer supported, the data from uart part will be transformed to the last UDP packet's address.

Here show 2 UDP client communicate with server, server send data to the last client communicates with it.

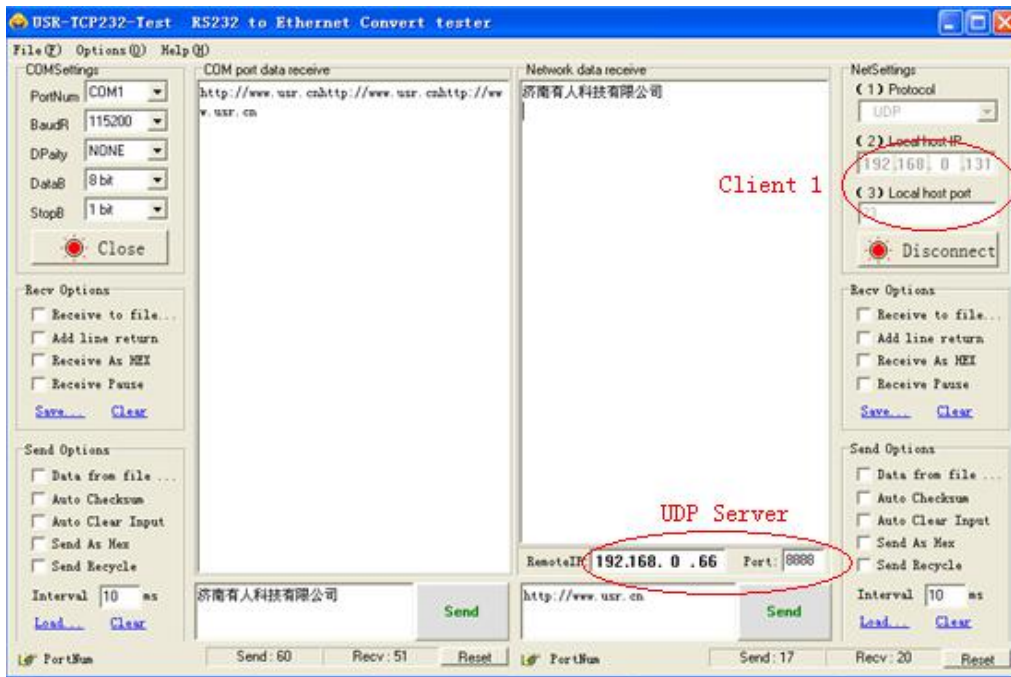

Diagram 3-5 Client 1 <-> server

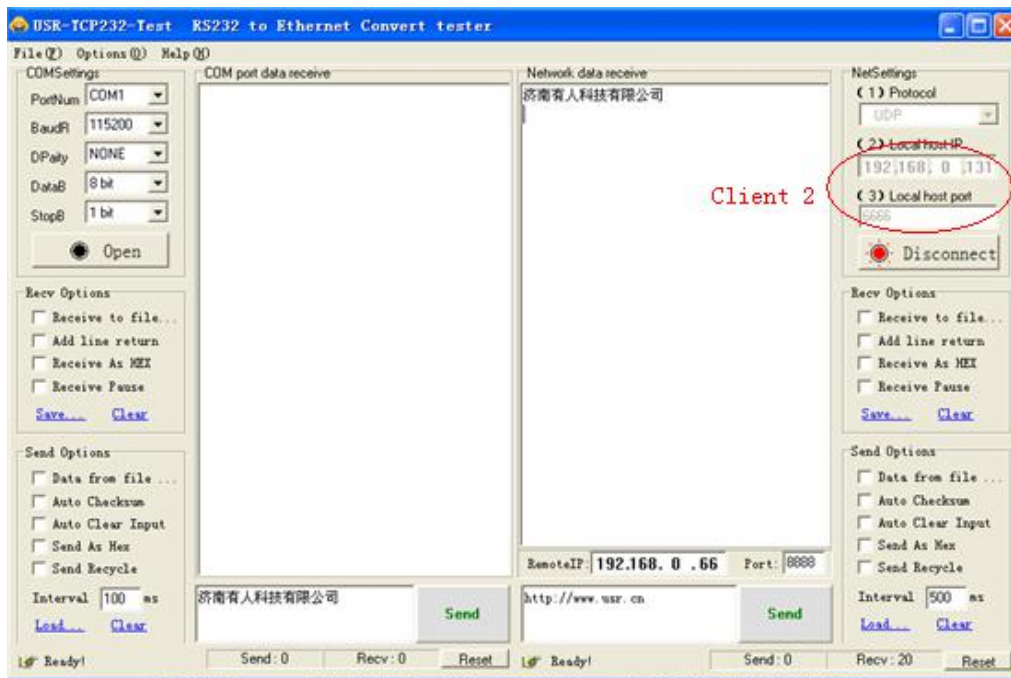

Diagram 3-6 Client 2 <-> server

### 3.4. TCP Server mode

TCP Server mode have 2 parameters: max link number and link type

1. max link number: 1 ~ 8;



parameter

Baud Rate:  bps

Data Size:  bit

Parity:

Stop Bits:  bit

Flow Control and RS485:

Local Port Number:

Remote Port Number:

Work Mode:

TCP Server detail:  type

Remote Server Addr:  [ N/A ]

Timeout:  seconds (< 256, 0 for no timeout)

UART packet Time:  ms (< 256)

UART packet length:  chars (<= 1460, 0 for no use)

Sync Baudrate(RF2217 similar):

Diagram 3-7 web page configuration

### 3.5. Httpd Client mode

This function is easier used for web page developer. We establish one web server page, add this:

```
[<?php echo $_GET['data']; ?>]
```

Means we can GET data from HTTP client's request. Open this URL:

test.usr.cn/1.php?data=12345, the web page is downbelow, we can see that the web server have got the data(12345),

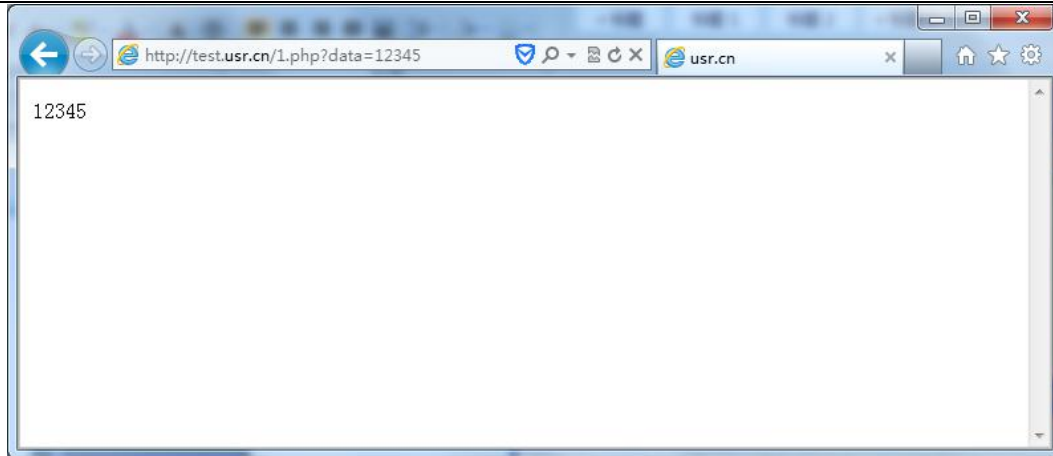
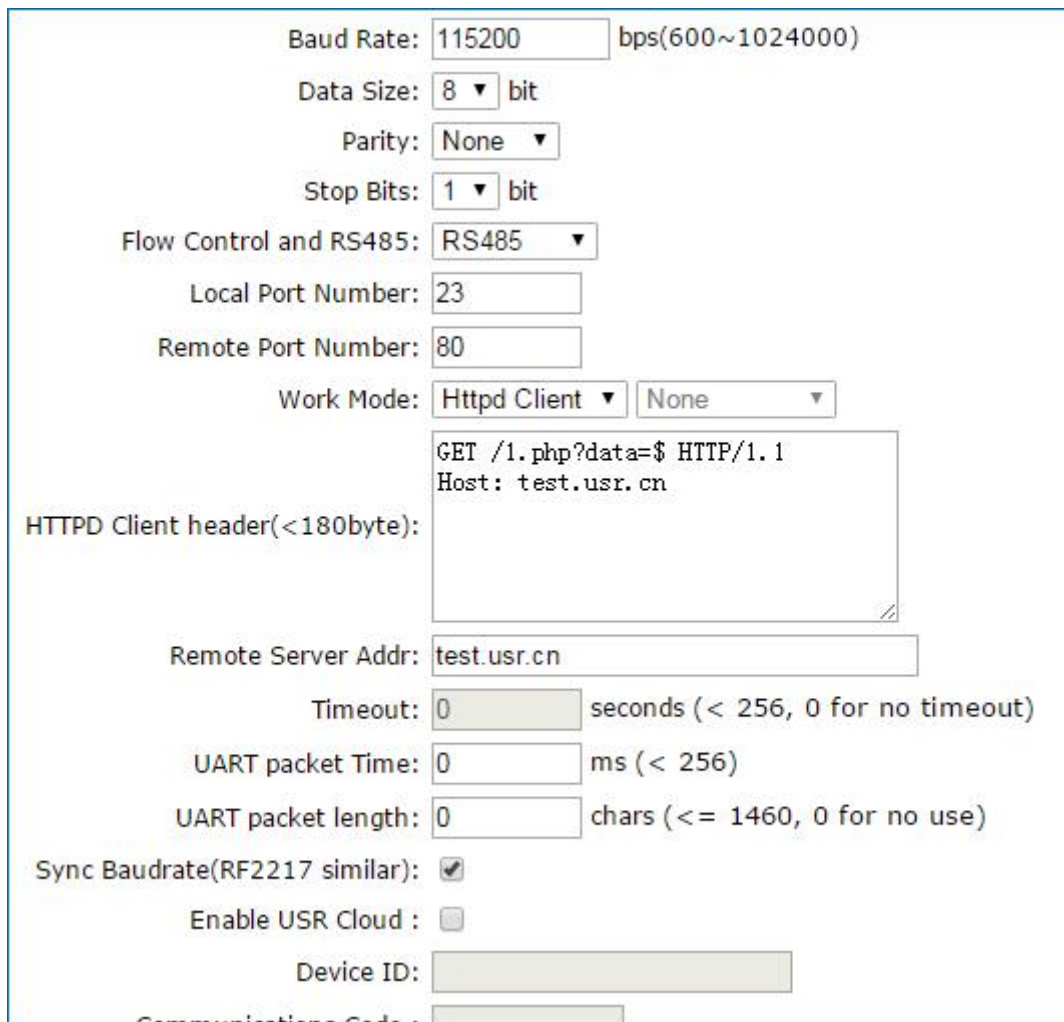

Diagram 3-8 Request `test.usr.cn/1.php?` and upload data

Then we take another way, set USR-K3 module Work mode HTTPD Client, Target address `test.usr.cn`, remote port 80.



The screenshot shows the configuration interface for the HTTPD Client mode. The settings are as follows:

- Baud Rate: 115200 bps(600~1024000)
- Data Size: 8 bit
- Parity: None
- Stop Bits: 1 bit
- Flow Control and RS485: RS485
- Local Port Number: 23
- Remote Port Number: 80
- Work Mode: Httpd Client
- HTTPD Client header(<180byte):
 

```
GET /1.php?data=$ HTTP/1.1
Host: test.usr.cn
```
- Remote Server Addr: test.usr.cn
- Timeout: 0 seconds (< 256, 0 for no timeout)
- UART packet Time: 0 ms (< 256)
- UART packet length: 0 chars (<= 1460, 0 for no use)
- Sync Baudrate(RF2217 similar):
- Enable USR Cloud :
- Device ID: [ ]
- Communications Code: [ ]

Diagram 3-9 config HTTPD Client

Open USR-TCP232-Test, and type in a string such as "12345", then send via comm port to USR-K3, and see the response from `test.usr.cn`.



In the response, all the data returned, but the http header from server will be returned, too. the user may need to parse this to get your data.

## 4. Hardware

About the new PCB libraries file, we can download it from website

<http://www.usriot.com/Download/221.html> .

### 4.1. Hardware

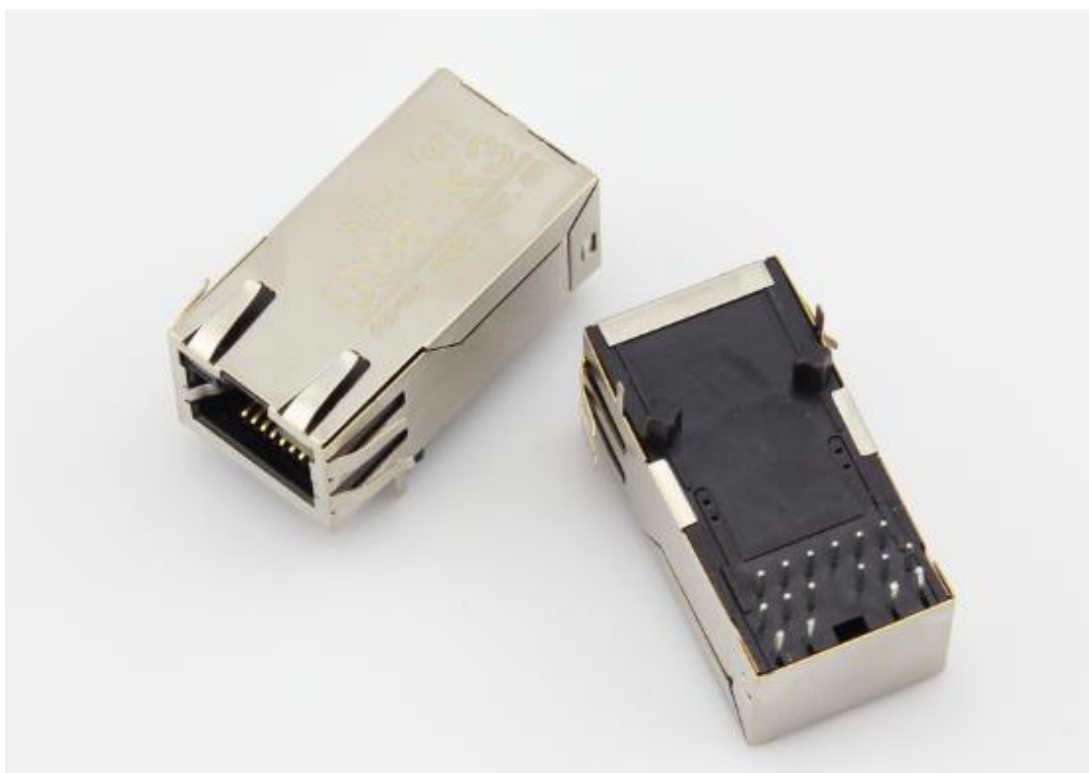

Diagram 4-1 USR-K3

- Mechanical dimension: 33.02 x 19.01 x 19.15 (mm, include the Shrapnel)
- 3.3V power input
- 1 \* UART (TTL, 3.3V)
- support hardware flow control(RTS/CTS)

### 4.2. Pin definition

Power supply socket, The input voltage range only DC 3.3V, average current 120 MA.

if your MCU's signal is 5V, pls add a signal convert between 3.3V and 5V

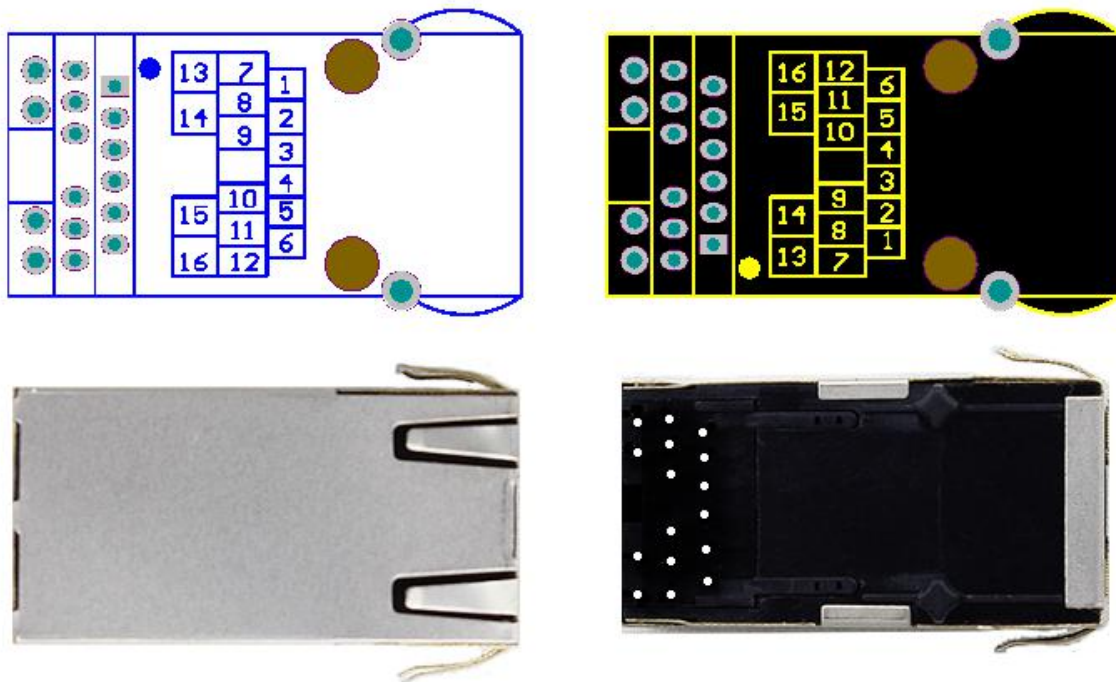
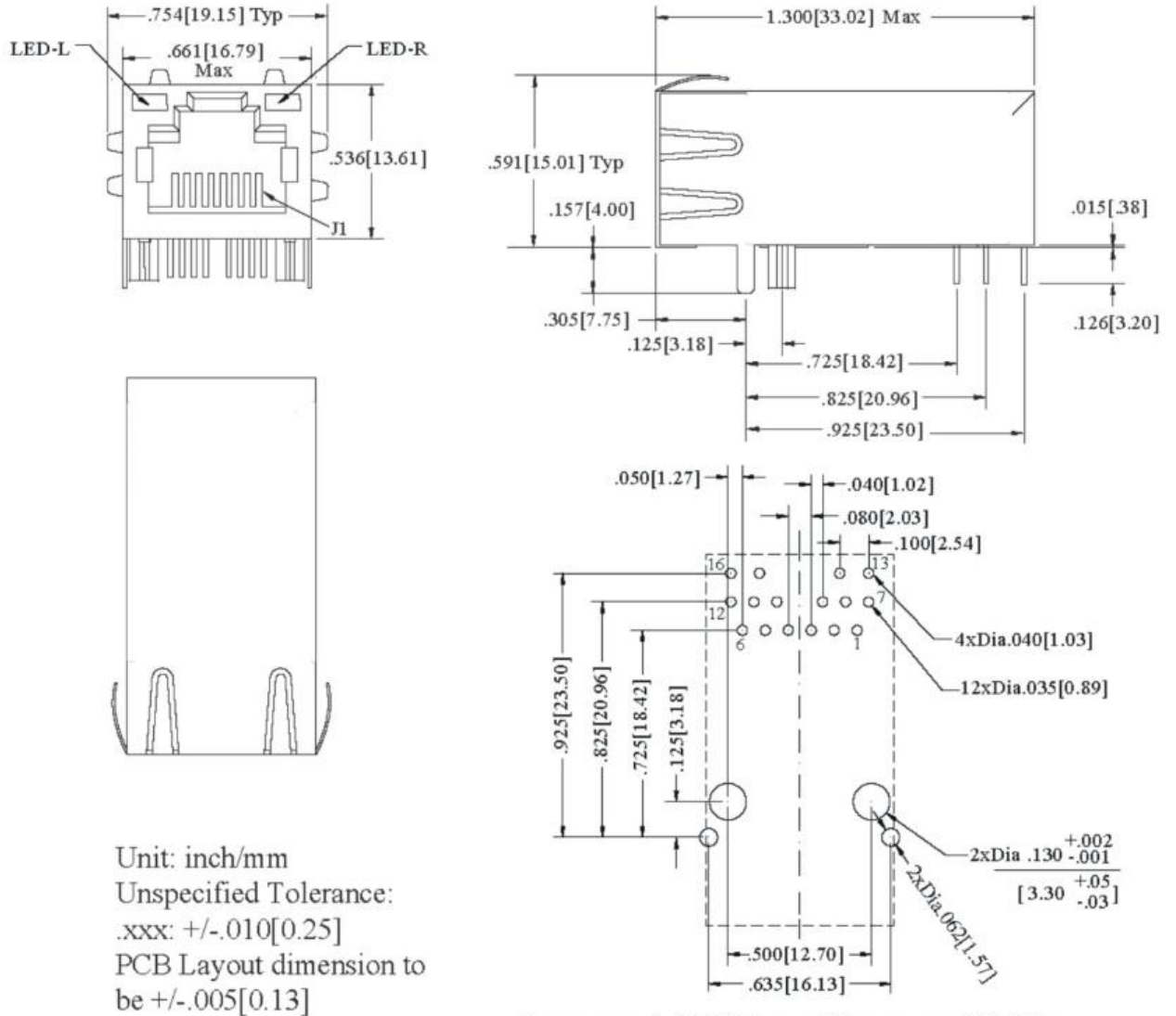

Diagram 4-2 pin diagram of K3(left for top view, right for bottom view)

ID	name	description
1	NC	Unused, pls leave it to float
2	NC	Unused, pls leave it to float
3	CTS	Clear to send
4	RST	Reset pin(give a constant 200ms low level make module reset)
5	RTS	Request to send(also muxed as RS485 enable tx pin, enable it from software in )
6	Reload	Unused, pls leave it to float
7	LED2	LED2, pls connect this pin to another LED2
8	RXD	Data receive pin for comm port
9	TXD	Data transmit pin for comm port
10	GND	ground
11	3V3	DC3.3V, only support 3.3V
12	LED1	LED1, pls connect this pin to another LED1
13	LED2	LED2, pls connect this pin to another LED2
14	LED_3V3	Power input for LED, pls connect this pin to another LED_3V3
15	LED_3V3	Power input for LED, pls connect this pin to another

		LED_3V3
16	LED1	LED1, pls connect this pin to another LED1

Diagram 4-3 Pin definition



Recommended PCB Layout Component Side View

Diagram 4-4 inches

### 4.3. Connection diagram

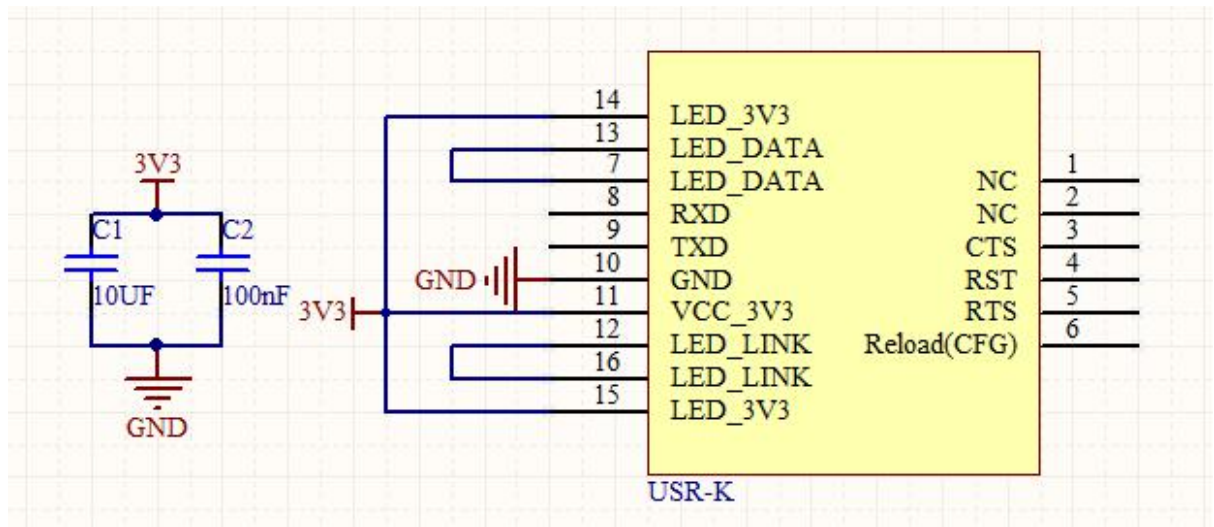

Diagram 4-5 connection diagram

This is connection diagram for USR-K3 when user design their product with K3, there is a few points we need to attend to

- Power K3 with a stable 3.3V
- Connect 2 LED\_3V3 together
- Connect 2 LED\_DATA together
- Connect 2 LED\_LINK together
- Connect RXD, TXD with user's MCU
- Leave the unused pin to a float state

### 4.4. LED

ID	name	Description
2	Link(green)	On RJ45, when ethernet physical link established, on.
3	Data(yellow)	On RJ45, when ethernet data communicate, toggle.

Diagram 4-6 LED definition

### 4.5. RJ45 interface

Ethernet port of module is 10 M / 100 M adaptive, support AUTO - MDIX, can connect cross-over or direct network cable directly. That is to say, you can use any kind of cable to connect with computer or other network device .

## 5. Parameters configuration

### 5.1. Web page

Recommend the user configure the module via webpage.

### 5.2. Network command(setup software)

1. Configure the module by software [USR-TCP232-M4,E45] setup V2.1.2.220

2. Provide configuration protocol

Down below is the Setup, <http://www.usriot.com/p/tcp-module/>

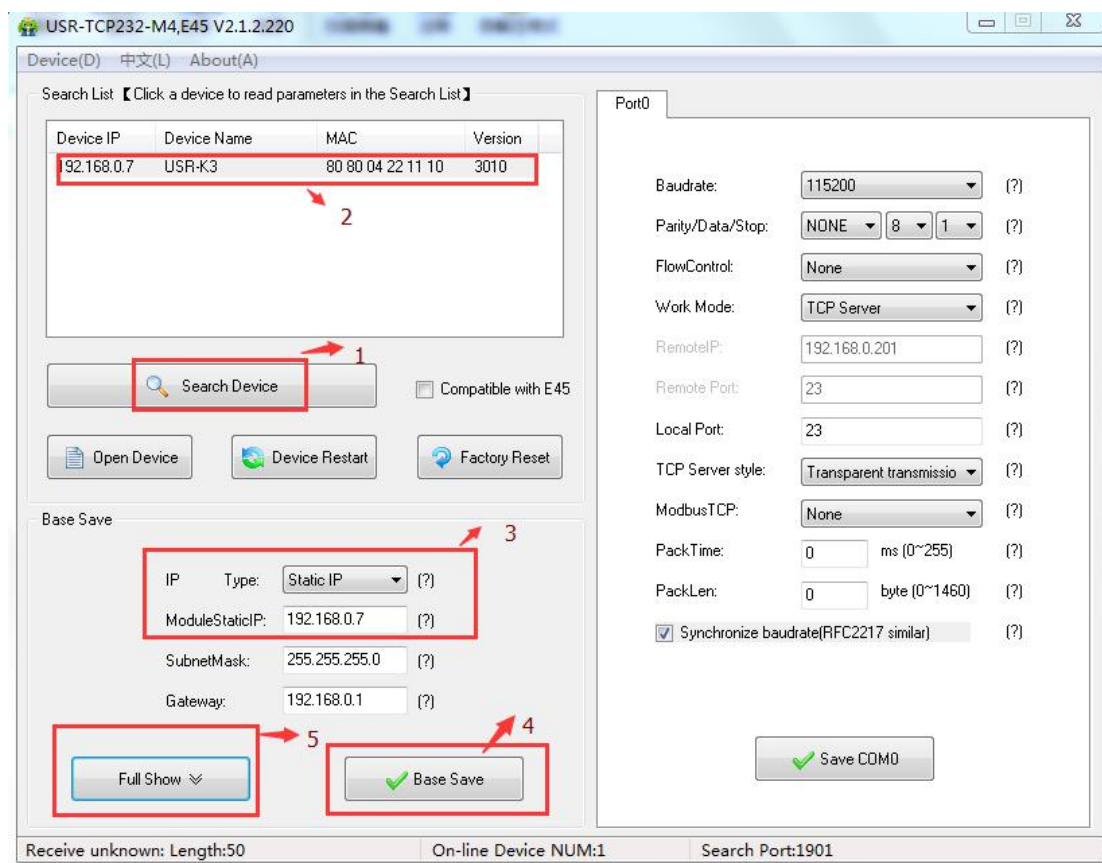

Diagram 5-1 Setup software

- (1) Click 'Search Device'
- (2) Select device in search list
- (3) Modified parameters such as static IP
- (4) Click 'Base Save', parameters will be saved and device restart; Re-search, module will show new parameters
- (5) Click "Full Show", please refer to the details:

Base Save

Websocket Port:	<input type="text" value="6432"/>	(?)	Device Name:	<input type="text" value="USR-K3"/>	(?)
Web Port:	<input type="text" value="80"/>	(?)	User MAC:	<input type="text" value="80 80 04 22 11 10"/>	(?)
Device ID:	<input type="text" value="1"/>	(?)	IP Type:	<input type="text" value="Static IP"/>	(?)
Device ID Type:	<input type="text" value="0"/>	(?)	ModuleStaticIP:	<input type="text" value="192.168.0.7"/>	(?)
User Name:	<input type="text" value="admin"/>	(?)	SubnetMask:	<input type="text" value="255.255.255.0"/>	(?)
Password:	<input type="text" value="admin"/>	(?)	Gateway:	<input type="text" value="192.168.0.1"/>	(?)

Receive unknown: Length:50 On-line Device NUM:1

## 6. Specific functions

### 6.1. Modbus RTU to ModbusTCP

As for this function, you can configure it by web page or setup program. Please refer to below example by setup program

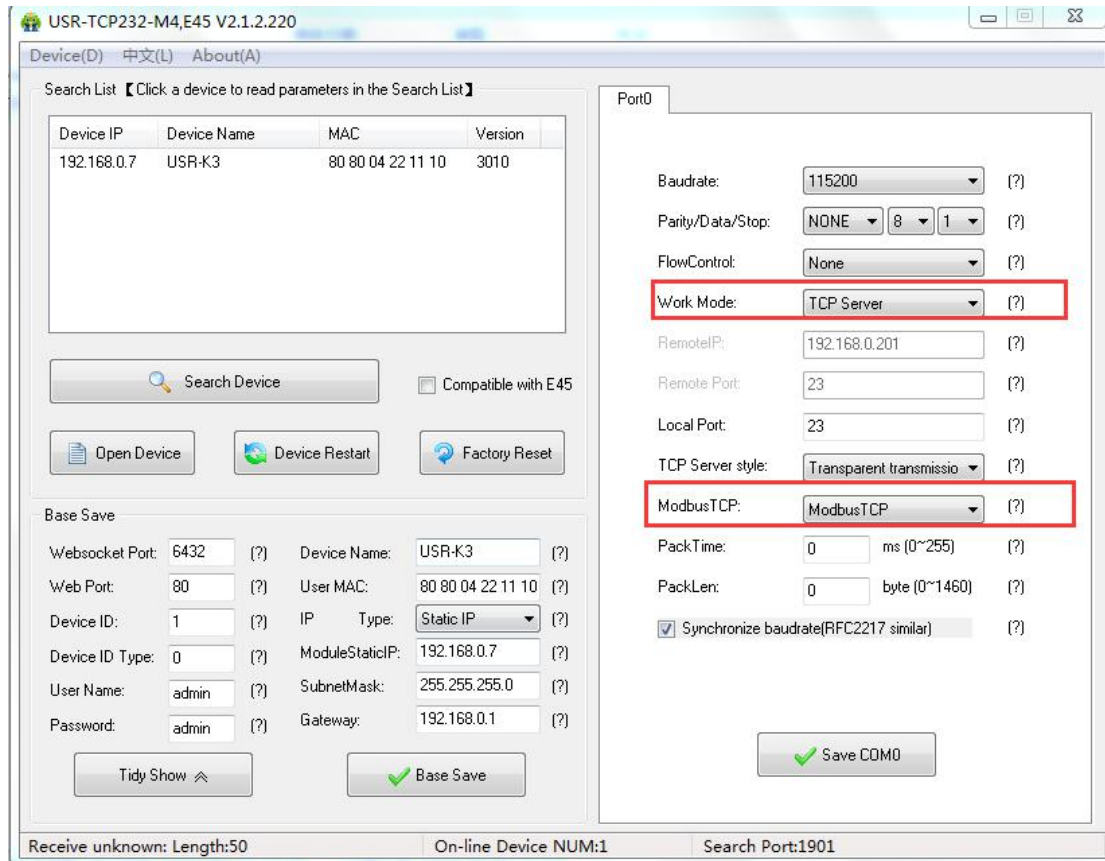

Diagram 6-1 choose ModbusTCP by setup program

Note: There are two options in this place "ModbusTCP":

- None, which showed we are using a standard Transparent mode, no protocol conversion.
- ModbusTCP, means we use protocol conversion from Modbus RTU to ModbusTCP.

The function acts as below:



Diagram 6-2 function description for ModbusTCP to modbus RTU

## 6.2. Hardware flow control(RTS/CTS)

If you want to use Hardware flow control, select it before using.

RS232 interface support hardware flowcontrol (RTS/CTS)



Pin name	Description	IO type	Operater
RTS	Request to Send	O	module
CTS	Clear to Send	I	Outside device(PC)

Diagram 6-3 Pin description

When RTS = 0, enable the other side to send, at this time, TTL is 0 volt, RS232 is -3V ~ -15V;

When CTS = 0, represent module is enabled to send, at this time, TTL is 0 volt, and RS232 is -3V ~ -15V;

When the logic is reverse, represent that disable the other side to send or was disabled the module to send.

When connect with PC's RS232 interface, we can use the serial cable(cross).

### 6.3. MAC address

In Current status page, we can see the currently MAC address in use. Diagram below is using the factory MAC.

parameter
Module Name: <b>USR-K3</b>
Firmware Revision: 3005
Current IP Address: 192.168.0.10
<b>MAC Address: d8-b0-4c-e0-86-0b</b>
Run Time: 0day: 0hour: 33min
TX Count(ETH) : 9955000 bytes
RX Count(ETH) : 9835000 bytes

Diagram 6-4 currently MAC in use

### 6.4. Packet time and Packet length

If packet time is 10ms, packet length 512 byte. Then it represent this meaning:

If there is no data since the last char received during the past 10ms, the current data will be send to remote server.

If the currently received data length exceed 512 byte, then the module will pack all the 512 byte and send to remote server.

The pack mechanism would be triggered if there is either 1 condition meet them.



If we set packet time and packet length to 0, then the module would use a mechanism of auto-packet, which have 4-byte-time packet time, and 1460 byte packet length(available only when firmware revision >= 3006).

## 6.5. Sync baud via net(2217)

This is a function similar to RFC2217(but different protocol), which can modify the device's comm parameters via ethernet(tcp or udp connection).

This option is checked by default.

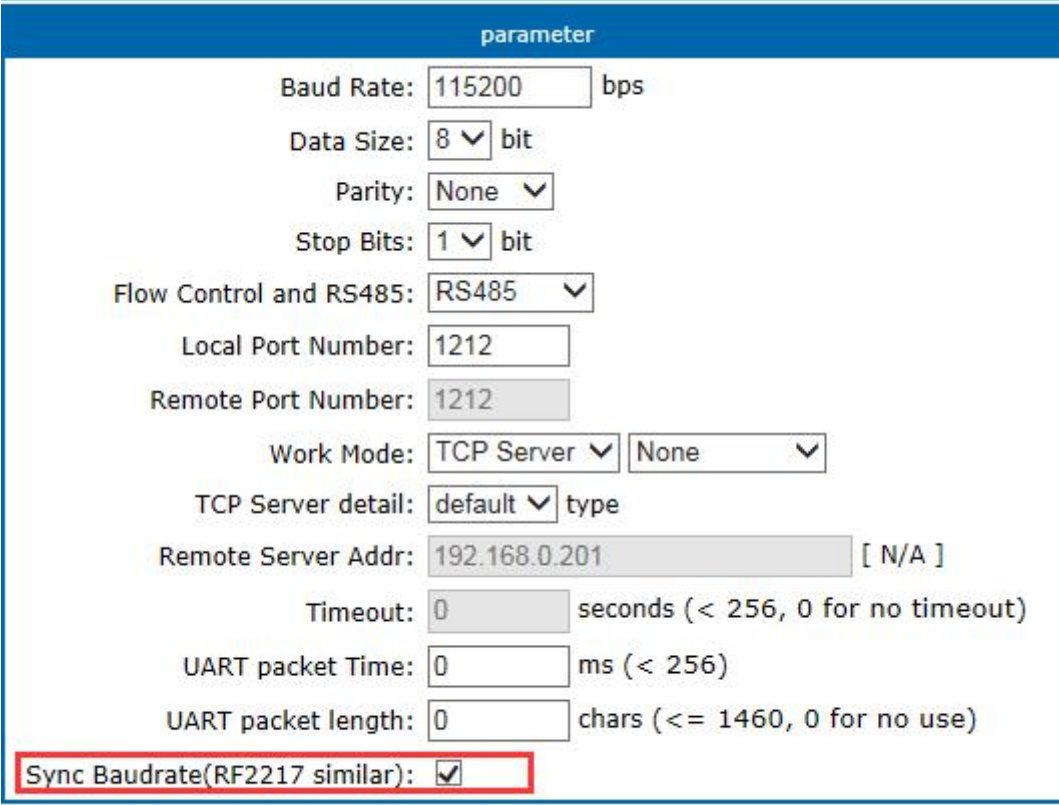

parameter	
Baud Rate:	115200 bps
Data Size:	8 bit
Parity:	None
Stop Bits:	1 bit
Flow Control and RS485:	RS485
Local Port Number:	1212
Remote Port Number:	1212
Work Mode:	TCP Server None
TCP Server detail:	default type
Remote Server Addr:	192.168.0.201 [ N/A ]
Timeout:	0 seconds (< 256, 0 for no timeout)
UART packet Time:	0 ms (< 256)
UART packet length:	0 chars (<= 1460, 0 for no use)
Sync Baudrate(RF2217 similar):	<input checked="" type="checkbox"/>

Save Cancel

Diagram 6-5 sync baud

## 6.6. Webserver port

The module have built-in webserver which allow user to setup parameters via webpage. Default port 80, but we could modify this port according to some special uses.

## 6.7. Module id and id type

All module have a 2 byte id, default 1; id type default 0

Reserved:

Webserver port:

Module id(use for indentify modue):  (1~65535)

Module id type:  (0/1/2/3)

MAC address:

User name:

Pass word:

Buffer data before connected:

Reset timeout:  second

Diagram 6-6 module id and id type

The id type have a mean as below.

ID type	description
0(by default)	No use
1	When module act as client(tcp or udp), after it connect to server, send 4 byte immediatly(2 byte Id + 2 byte Id-Complement, 00 01 FF FE by default); This can be used for USR-D2D service
2	add 4-byte before each frame send to server
3	Both 1 and 2

## 6.8. Device name

User can modify this name, 15 chars max.

## 6.9. Buffer data before connected

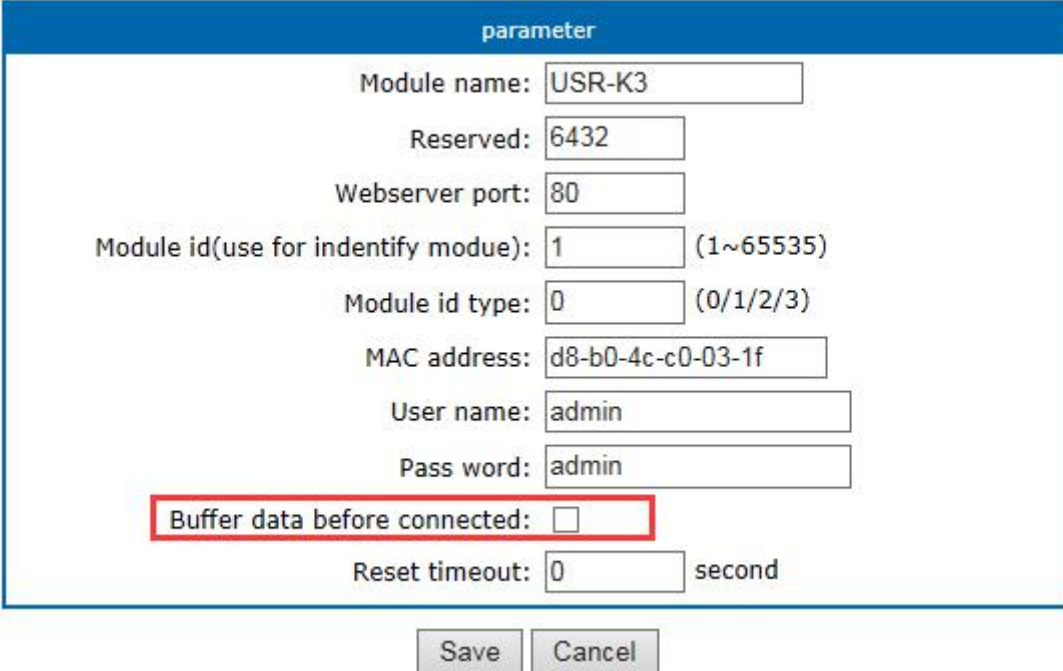

parameter

Module name:

Reserved:

Webserver port:

Module id(use for indentify modue):  (1~65535)

Module id type:  (0/1/2/3)

MAC address:

User name:

Pass word:

Buffer data before connected:

Reset timeout:  second

Diagram 6-7 buffer data or not

Default not checked. That is before TCP connected, all the data comm port previously received , will be flushed.

If checked, all the data comm port previously received would be saved and send to server after connected.

## 6.10. Reset timeout

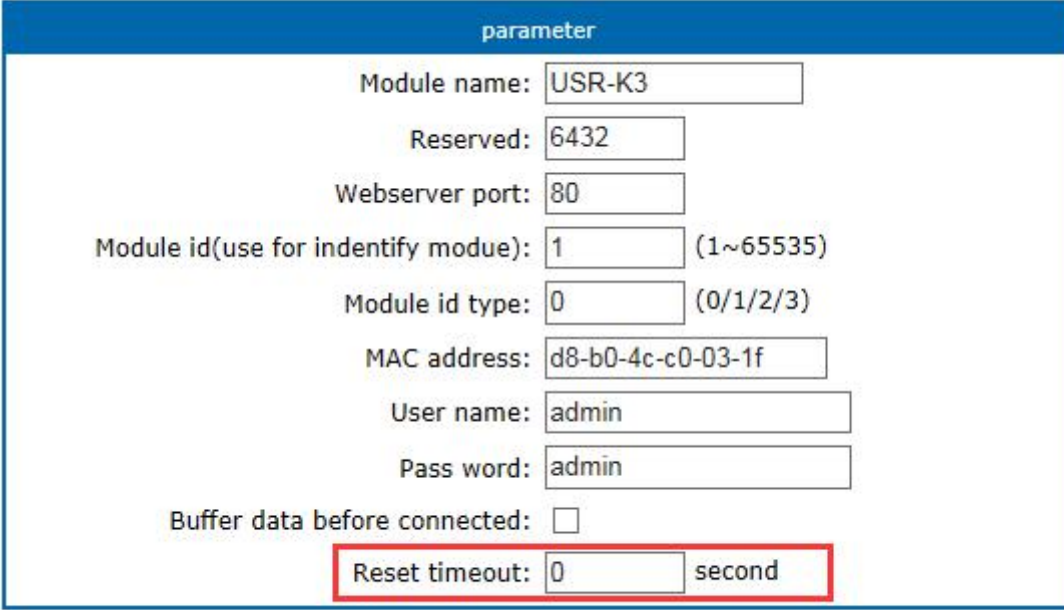

The screenshot shows a configuration window titled "parameter" with the following fields:

- Module name: USR-K3
- Reserved: 6432
- Webserver port: 80
- Module id(use for indentify modue): 1 (1~65535)
- Module id type: 0 (0/1/2/3)
- MAC address: d8-b0-4c-c0-03-1f
- User name: admin
- Pass word: admin
- Buffer data before connected:
- Reset timeout: 0 second (highlighted with a red box)

At the bottom of the window are "Save" and "Cancel" buttons.

Diagram 6-8 Reset timeout

Default 0, unit is second. When this value between 0~60, the reset timeout function would be no use. When this value is higher than 60, the module will restart if there is no data received during this time.

## 6.11. Local IP config

There is Static IP and DHCP, Static IP by default.

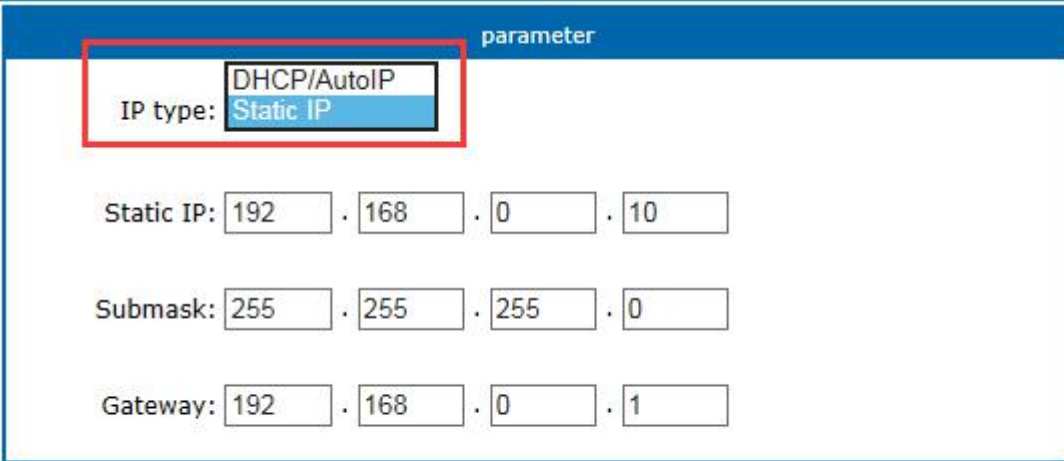

The screenshot shows a configuration window titled "parameter" with the following fields:

- IP type: DHCP/AutoIP / Static IP (highlighted with a red box)
- Static IP: 192 . 168 . 0 . 10
- Submask: 255 . 255 . 255 . 0
- Gateway: 192 . 168 . 0 . 1

At the bottom of the window are "Save" and "Cancel" buttons.

Diagram 6-9 Local IP config

### 6.11.1. Static IP

Type in the ip address you want to config, such as 192.168.0.10 (192.168.0.7 by default)

Submask usually 255.255.255.0

Gateway usually 192.168.0.1 (your router's ip address)

### 6.11.2. DHCP

Choose DHCP and save, then reset to take effect. The module will get it's ip address in 5-10seconds, after that you can search for it in the setup software.

### 6.12. DNS

The module can visit both ip or remote domain name, user can type in the domain name in the IP box.

The domain name max length will be 30 chars.

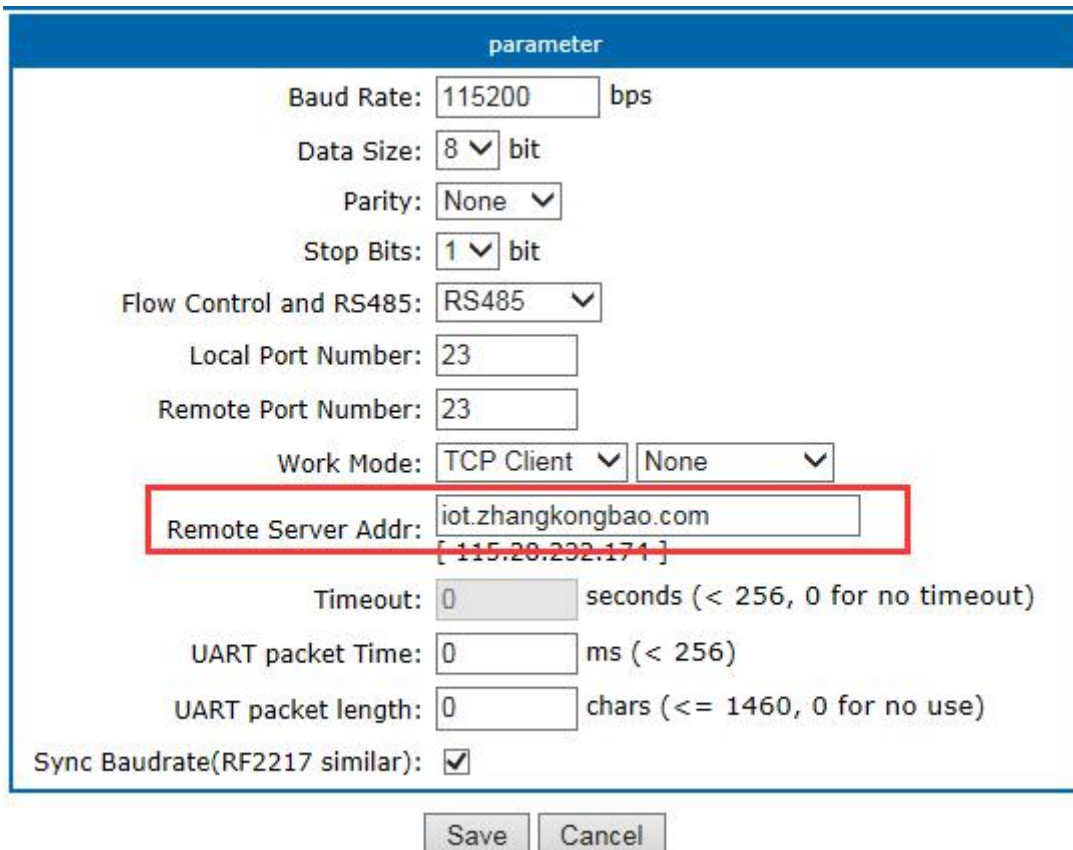

parameter

Baud Rate: 115200 bps

Data Size: 8 bit

Parity: None

Stop Bits: 1 bit

Flow Control and RS485: RS485

Local Port Number: 23

Remote Port Number: 23

Work Mode: TCP Client None

Remote Server Addr: iot.zhangkongbao.com  
[ 115.20.232.171 ]

Timeout: 0 seconds (< 256, 0 for no timeout)

UART packet Time: 0 ms (< 256)

UART packet length: 0 chars (<= 1460, 0 for no use)

Sync Baudrate(RF2217 similar):

Save Cancel

Diagram 6-10 domain name or IP

## 6.13. Comm param

The baud ranges from 600bps to 1024kbps, user can define this to any value.

For the serial device server of RS232 interface, such as TCP232-410, the RS232 interface can only up to 115200bps.

Databit range 5, 6, 7, 8;

Paritybit range None, Odd, Even, Mark, Space

Stopbit range 1, 2

## 6.14. Firmware revision



Diagram 6-11 Firmware revision

## 6.15. RS485

The module's RTS pin, is configured as 485\_EN pin, by default.

If you want to extend a RS485 interface for TCP232-E or TCP232-ED2, you can connect this RTS pin to the 485 IC's enable pin.

## 6.16. Firmupdate

Use search and config software  **USR-TCP232-M4&E45 V2.1.0.38** to update firmware, there is a few point need be be attention

- Asking for the firmware from us
- only one module for one time, can not cross network segment.
- You must connect module directly with your PC with a single net cable, and set your PC with a static IP in same segment with module

1. Search and select one module

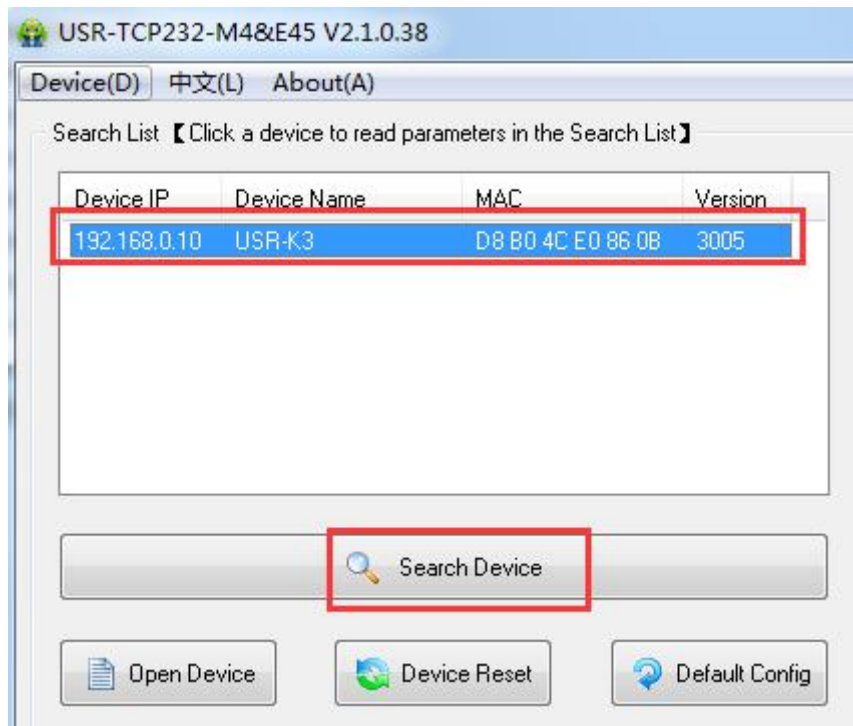

Diagram 6-12 search and select

2. 'Device' -> firmware update

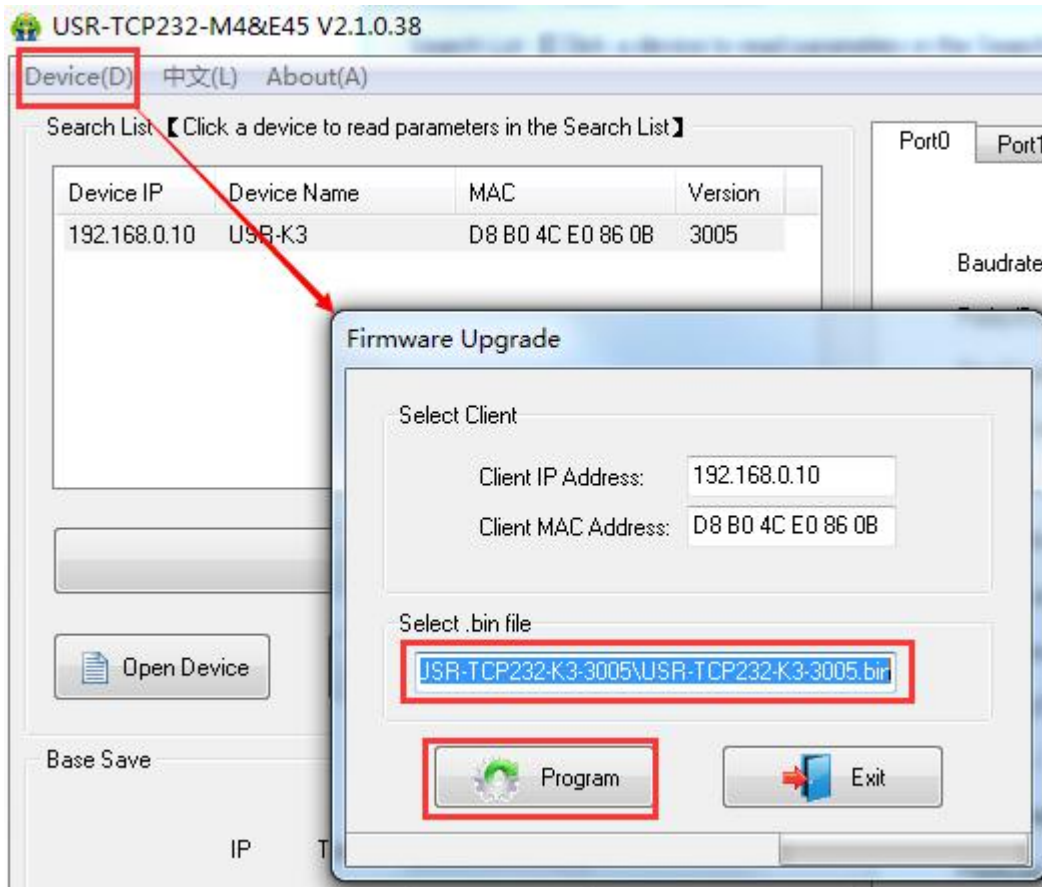
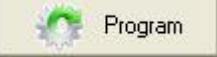

Diagram 6-13 firmware update



Click  to start update progress. If you see a progress bar, means it have started to update.

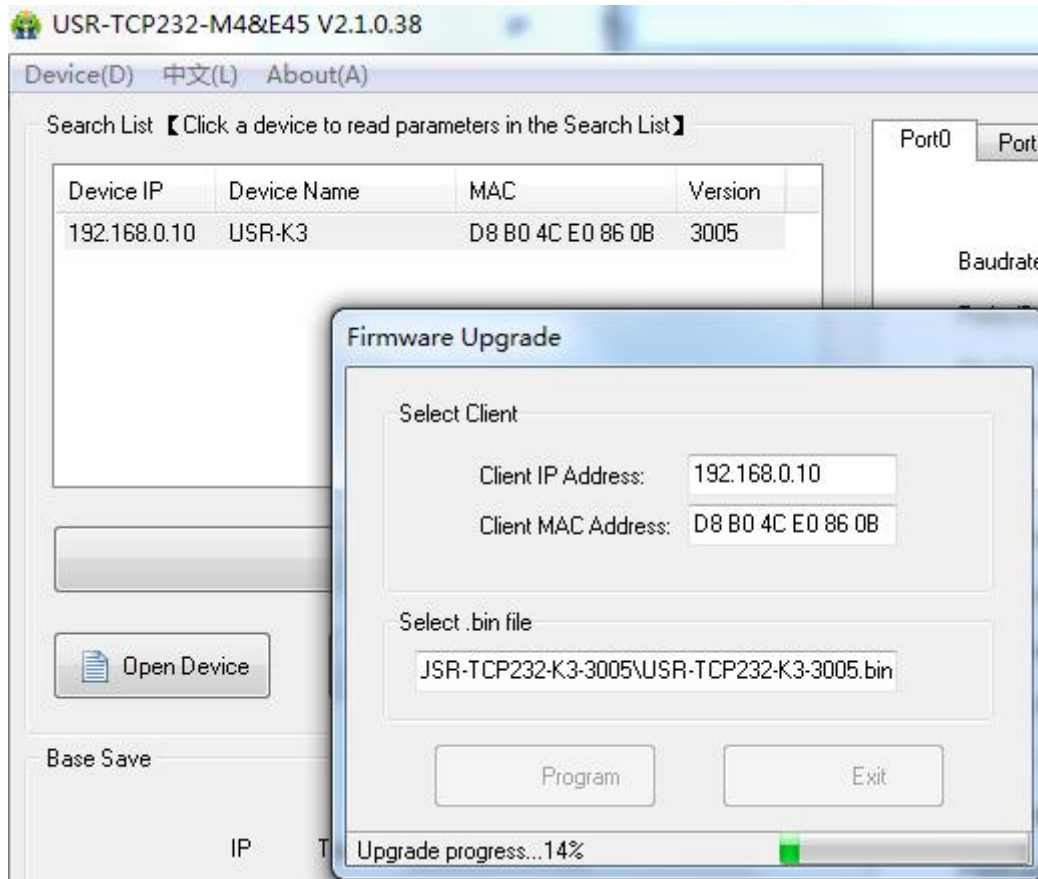

Diagram 6-14 in update progress

3. When it approaches 100%, Update success, click exit.

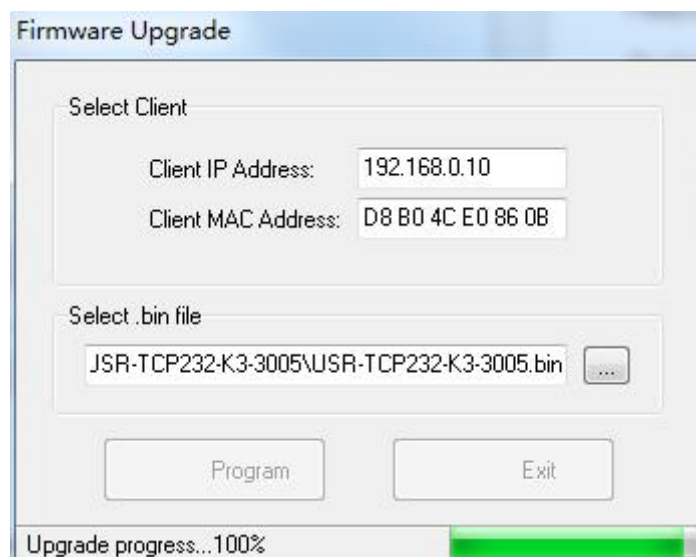

Diagram 6-15 success

Note: After update, if can not search module, restore to factory will fix this problem.



## 6.17. Common questions

### 6.17.1. Work across network segment

If your TCP232 device's IP is 192.168.0.7, and remote PC's IP is 192.168.1.7, we need to config.

Subnet mask of TCP232 device, PC, and router to 255.255.0.0, if not, the TCP232 module will not communicate normally.

### 6.17.2. Ping is OK but can not open web pages

Some possible causes

1. Module is set a static ip and conflicts with another ethernet device.
2. Cross network and false subnet mask .
3. HTTP server port is modified(default 80).

Solutions:

1. Set another static or use DHCP.
2. Set correct subnet mask.
3. Set this port to 80 or open web page with correct port.

### 6.17.3. After firm update, can not open web page

Reload this module back to factory settings.

### 6.17.4. When connection established, server received serval chars

Possible causes.

- 1) Module id type is not 0.

Solutions.

- 1) Module id type set 0.

### 6.17.5. Every serval seconds, module reconnect

Maybe there is a network device which is same ip to module, pls check if ip conflict.

## 7. Contact us

Company: Jinan USR IOT Technology Co., Ltd

Address: Floor 11, Building 1, No. 1166 Xinluo Street, Gaoxin Distric, Jinan, Shandong, 250101

China

Tel: 86-531-55507297 86-531-88826739-803

Web: <http://www.usriot.com/>

Skype: lisausr

Support: <http://h.usriot.com/index.php?c=frontTicket&m=sign>

Email: [sales@usr.cn](mailto:sales@usr.cn) [tec@usr.cn](mailto:tec@usr.cn)

## 8. Modified history

- 1) V1.0.1 doc established by Huibin Li
- 2) V1.0.3 correct website link and picture mistake
- 3) V1.0.5 add support center website
- 4) V1.0.6 update pin definition picture for K3
- 5) V1.0.7 add reset timeout and buffer data
- 6) V1.0.8 new address